

CATALOGO / CATALOGUE

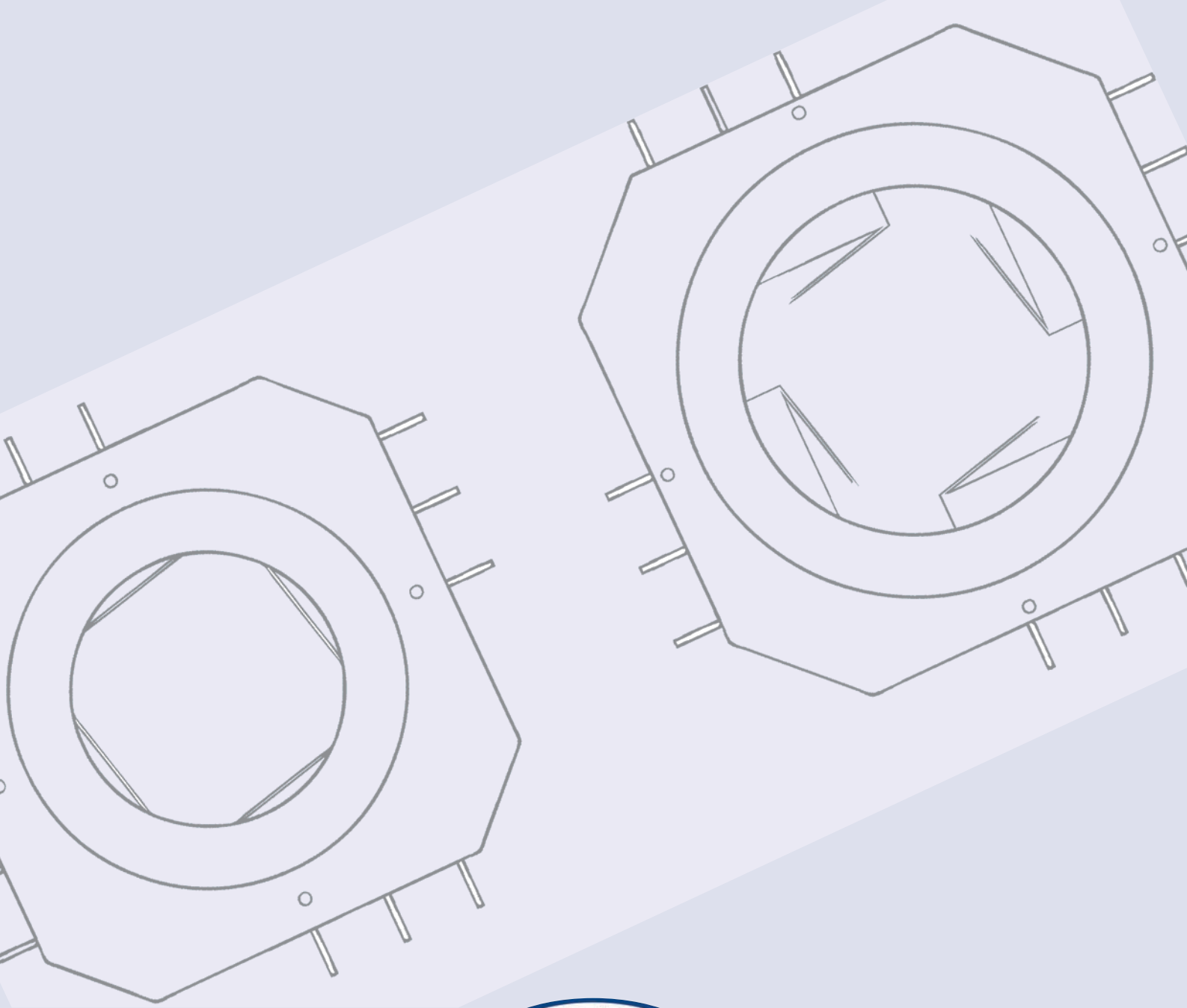

**ACCESSORI BREVETTATI PER VIDEOGAMES
PATENTED VIDEOGAMES ACCESSORIES**





Sede Commerciale:

Via Madonna del Riposo, 90
00165 Roma
tel. 06 66 29 730 - 06 66 30 802
fax. 06 66 29 730
e-mail: info@edierre.it
www.edierre.it

Sede Legale:

Via dell'Aeroporto, 155
00175 Roma
P. IVA 05404301003



CATALOGO / CATALOGUE

w w w . e d i e r r e . i t



il marchio edierre

joystick

minijoystick

joypad

pulsanti luminosi

minipulsanti luminosi

pulsanti in acciaio

serie deluxe

pulsanti semplici

pulsanti multitasto

componentistica



the brand edierre

joystick

minijoystick

joypad

illuminate buttons

small illuminate buttons

steel buttons

deluxe series

simple buttons

buttons multikey

components

UN PÒ DI STORIA

Un piccolo joystick in nylon nero, praticamente indistruttibile.

È la prima invenzione e il primo prodotto EDIERRE.

Era il 1982, con questo prodotto dotato del rivoluzionario sistema di aggancio alla plancia tramite una ghiera, brevettato EDIERRE, iniziava una nuova era nel settore del videogames.

Da allora l'ingegneria dell'azienda apprezzata anche in ambito internazionale ha cercato numerosi modelli innovativi e muniti di altri brevetti EDIERRE come il porta scheda e il sistema di aggancio a baionetta del supporto microswitch al corpo del pulsante.

LA SCELTA DELLA QUALITÀ

La prima vera novità è il materiale usato. I prodotti sono realizzati con materiali termoplastici affinché le parti più sollecitate durante l'utilizzo possano opporre maggior resistenza.

Sono progettati con una attenzione inedita finalizzata a semplificare l'installazione e la manutenzione da parte dell'operatore del settore sia esso un costruttore di videogames, un tecnico o un semplice noleggiatore. La scelta della qualità prosegue con i componenti elettrici che sono soltanto di prima scelta e osservanti le normative.

Infine la ricerca della affidabilità e della robustezza fin dalla fase di progettazione e la cura nell'assemblaggio completano il quadro delle caratteristiche che hanno fatto dei prodotti EDIERRE lo standard qualitativo di riferimento nel settore.

DIFFIDATE DALLE IMITAZIONI

Per i motivi suddetti i prodotti EDIERRE sono stati imitati nel design e contraffatti innumerevoli volte, in Italia e nel mondo, senza raggiungere lo standard di affidabilità degli originali EDIERRE. Ogni singolo prodotto ha il marchio EDIERRE.



È un marchio di proprietà esclusiva della EDIERRE II s.r.l., l'unica ideatrice, produttrice e distributrice, anche a livello internazionale, di tutti i prodotti contenuti nel presente catalogo.

A LITTLE BIT OF HISTORY

A small joystick made of black nylon, practically eternal.

It's the first invention and the first EDIERRE product.

It was the year 1982 and with this product, made with a revolutionary system to hook in on the placeholder, an EDIERRE registered Patent, a new era in the videogames industry started.

Since then, the engineering of the firm that has been appreciated on an international level has built many innovative products, all with patents EDIERRE such as the placeholder or the mounting system for the microswitches without bolts.

THE CHOICE FOR QUALITY

The first new thing in the material. All products are made of thermoplastic materials so the parts that are under stress can resist better during usage.

The products are projected with a special attention towards simplifying the installation and the maintenance, taken care by whoever puts them in place, an operator of the business or a technician or even just someone who rents the videogames.

The choice for quality continues by picking the electrical components that are all first choice and CE certified.

Finally, strength and durability are standards that make EDIERRE one of the leading brands for videogames accessories.

BEWARE OF IMITATIONS!

For such reasons EDIERRE products have been copied many times, in Italy and throughout the world, without reaching the quality standards of the originals. Every product has the logo EDIERRE impressed on it.



is a logo of exclusive property of EDIERRE II S.r.l., the only manufacturer and distributor, on all levels, of all the products contained in this catalogue.

MOD. 01

- Joystick universale brevettato in nylon.
- Sistema semplificato di montaggio alla plancia senza bulloni.
- Contatti: 4 microswitches Honeywell come dotazione standard.
- Impugnatura: conica.
- Posizioni: 4-8 con selezionatore.
- Colore: nero.

ENGLISH

- Universal patented joystick made of nylon.
- Simplified assembly system, mounts in the control panel without bolts.
- Contacts: 4 Honeywell microswitches fitted as standard.
- Handle: cone-shaped.
- Positions: 4 or 8 selectable.
- Colour: black.

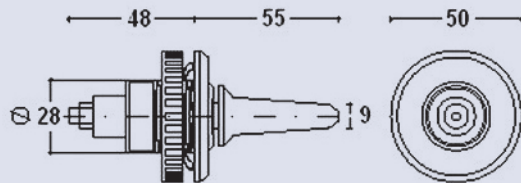

MOD. 02

- Joystick brevettato in nylon con pulsante incorporato.
- Sistema semplificato di montaggio alla plancia senza bulloni.
- Contatti: 5 microswitches Honeywell come dotazione standard.
- Impugnatura: conica.
- Posizioni: 8+1.
- Colore: rosso/ nero.

ENGLISH

- Patented joystick made of nylon with pushbutton on top.
- Simplified mounting system into the control panel without bolts.
- Contacts: 5 Honeywell microswitches fitted as standard.
- Handle: cone-shaped.
- Positions: 8+1 selectable.
- Colour: red/ black.

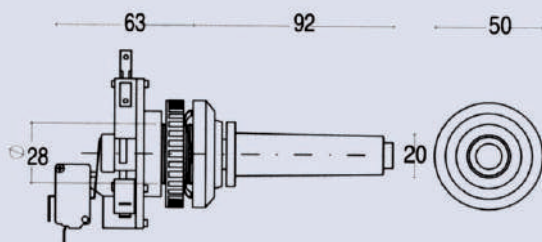

MOD. 02/P

- ❑ Joystick universale brevettato in nylon.
- ❑ Sistema semplificato di montaggio alla plancia senza bulloni.
- ❑ Contatti: 4 microswitches Honeywell come dotazione standard.
- ❑ Impugnatura: sferica.
- ❑ Posizioni: 4-8 con selezionatore.
- ❑ Colore: rosso/ nero, blu/ giallo.

Disponibile anche nella versione:

Mod 02/P mini Joystick con impugnatura corta.

Mod 02/P extra Joystick con boccola filettata lunga, adatto al montaggio su plancie in legno o di spessore considerevole.

ENGLISH

- Universal patented joystick made of nylon.
- Simplified mounting system into the control panel without bolts.
- Contacts: 4 Honeywell microswitches fitted as standard.
- Handle: round - shaped.
- Positions: 4 or 8 selectable.
- Colour: red/ black/ blue/ yellow.

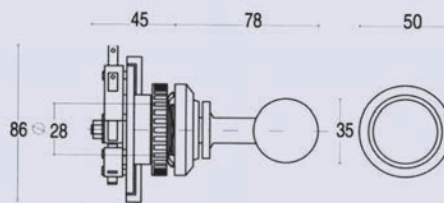

MOD. 010

- ❑ Joystick universale brevettato in nylon.
- ❑ Nuovo design dalle linee morbide, impugnatura più maneggevole ed ergonomica.
- ❑ Sistema semplificato di montaggio alla plancia senza bulloni.
- ❑ Contatti: 4 microswitches Honeywell come dotazione standard.
- ❑ Posizioni: 4-8 con selezionatore.
- ❑ Colore: tutte le combinazioni di rosso/ nero, blu/ giallo.

Disponibile anche nella versione:

Mod 010/ L extra - Joystick con boccola filettata lunga adatta al montaggio su plancie in legno o di spessore considerevole.

ENGLISH

- Universal patented joystick made of nylon.
- New soft design, more handy and ergonomic handle.
- Simplified mounting system into the control panel without bolts.
- Contacts: 4 Honeywell microswitches fitted as standard.
- Positions: 4 or 8 selectable.
- Colour: all the combinations of red/ black and blue/ yellow.

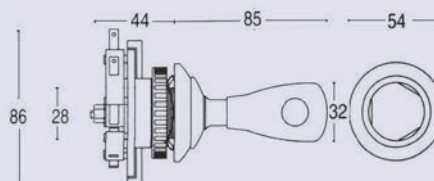



mini joystick

MOD. 011/ SM24 e 011/SM29

- Joystick in nylon.
- Sistema di montaggio brevettato senza bulloni.
- Foro di montaggio: 24mm - 29mm
- Microswitch: 4 sub-miniature in dotazione
- Posizioni: 8.
- Colori: rosso/ blu/ nero/ verde/ giallo.
- Colore della base: nero satinato.

ENGLISH

- Minijoystick made of nylon ideal for small control panels.
- Simplified mounting system into the control panel without bolts.
- Mounting Hole: 24mm - 29mm.
- Contacts: 4 sub-miniature switches fitted as standard.
- Positions: 8.
- Colour: red/ black/ blue/ yellow/ green.
- Base colour: glazed black.

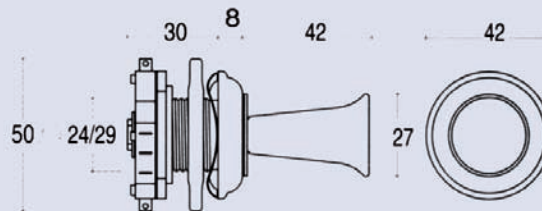

MOD. 012/ SM 24 e 012/SM29

- Joystick in nylon.
- Sistema di montaggio brevettato senza bulloni.
- Foro di montaggio: 24mm - 29mm
- Microswitch: 4 sub-miniature in dotazione
- Posizioni: 8.
- Colori: rosso/ blu/ nero/ verde/ giallo.
- Colore della base: nero satinato.

ENGLISH

- Minijoystick made of nylon ideal for small control panels.
- Simplified mounting system into the control panel without bolts.
- Mounting hole: 24mm - 29mm.
- Contacts: 4 sub-miniature switches fitted as standard.
- Positions: 8.
- Colour: red/ black/ blue/ yellow/ green.
- Base colour: glazed black.

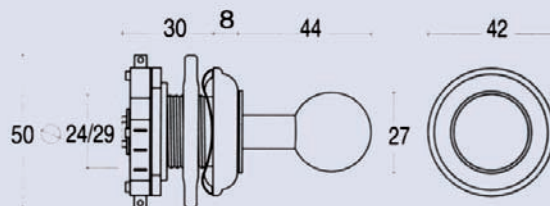

MOD. 021

- ❑ Joypad universale in nylon.
- ❑ Sistema semplificato di montaggio alla plancia senza bulloni.
- ❑ Contatti: 4 microswitches Honeywell ultraleggeri come dotazione standard.
- ❑ Posizioni: 4-8.
- ❑ Colore: tutte le combinazioni di rosso/ nero/ blu/ giallo.
- ❑ Foro di montaggio: 29mm.

ENGLISH

- Universal joypad made of nylon.
- Simplified assembly system, mounts system in the control panel without bolts.
- Contacts: 4 soft-tuch Honeywell microswitches fitted as standard.
- Positions: 4 or 8 selectable.
- Colour: all the combinations of red/ black/ blue/ yellow.
- Mounting hole: 29mm.

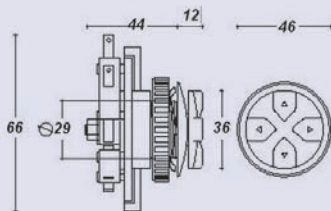

MOD. 021/ SM29

- ❑ Joypad universale in nylon.
- ❑ Sistema semplificato di montaggio alla plancia senza bulloni.
- ❑ Contatti: 4 subminiature switches come dotazione standard.
- ❑ Posizioni: 4-8.
- ❑ Colore: tutte le combinazioni di rosso/ nero/ blu/ giallo.
- ❑ Foro di montaggio: 29mm.

ENGLISH

- Universal joypad made of nylon.
- Simplified assembly system, mounts system in the control panel without bolts.
- Contacts: 4 sub-miniature switches fitted as standard.
- Positions: 4 or 8 selectable.
- Colour: all the combinations of red/ black/ blue/ yellow.
- Mounting hole: 29mm.

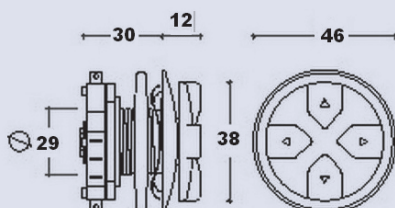

MOD. 04

- Pulsante rotondo luminoso in nylon con lampadina incorporata.
- Contatti: 1 microswitch standard Honeywell.
- Portamicro con attacco a baionetta antiganciamento.
- Lampadina: 6v o 12v - 2w o 1,2w o led 12v.
- Colore della base: nero.
- Colore dei tasti: rosso/ giallo/ blu/ verde/ bianco.
- Disponibile stampato.



ENGLISH

- Illuminated round pushbutton made of nylon with built-in lamp.
- Contacts: 1 standard Honeywell microswitch
- Micro-holder with bayonet security connection.
- Lamp: 6v or 12v - 2w or 1,2w or led 12v.
- Base colour: black.
- Button colours: red/ blue/ yellow/ green/ white.
- Custom legend lettering available.

FORO DI MONTAGGIO
MOUNTING HOLE

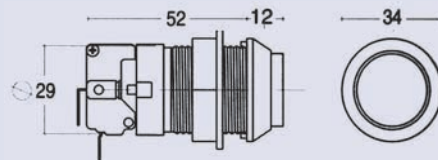
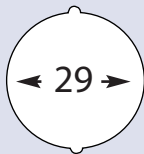

MOD. 04/ TR

- Pulsante rotondo luminoso in policarbonato trasparente con lampadina incorporata.
- Contatti: 1 microswitch Honeywell come dotazione standard.
- Portamicro con attacco a baionetta antiganciamento.
- Lampadina: 6v o 12v - 2w o 1,2w o led 12v.
- Colore della base: trasparente/ rosso/ giallo/ verde / blu.
- Colore dei tasti: rosso/ giallo/ blu/ verde/ bianco.
- Disponibile stampato.



ENGLISH

- Illuminated round pushbutton made of translucent polycarbonate with built-in lamp.
- Contacts: 1 Honeywell microswitch fitted as standard.
- Micro-holder with bayonet security connection.
- Lamp: 6v or 12v - 2w or 1,2w or led 12v.
- Base colour: translucent/ red/ yellow/ green/ blue.
- Button colours: red/ blue/ yellow/ green/ white.
- Custom legend lettering available.

FORO DI MONTAGGIO
MOUNTING HOLE

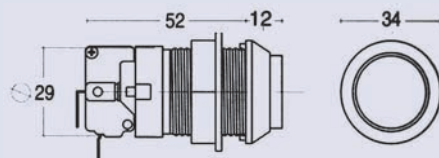
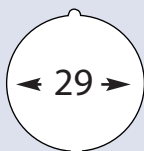

MOD. 05

- ❑ Pulsante quadrato luminoso in nylon con lampadina incorporata.
- ❑ Contatti: 1 microswitch Honeywell come dotazione standard.
- ❑ Portamico con attacco a baionetta antiganciamento.
- ❑ Lampadina: 6v o 12v - 2w o 1,2w o led 12v.
- ❑ Colore della base: nero.
- ❑ Colore dei tasti: rosso/ giallo/ blu/ verde/ bianco.
- ❑ Disponibile stampato.



ENGLISH

- Illuminated square pushbutton made of nylon with built-in lamp.
- Contacts: 1 standard Honeywell microswitch.
- Micro-holder with bayonet security connection.
- Lamp: 6v or 12v - 2w or 1,2w or led 12v.
- Base colour: black.
- Button colours: red/ blue/ yellow/ green/ white.
- Custom legend lettering available.

FORO DI MONTAGGIO
MOUNTING HOLE

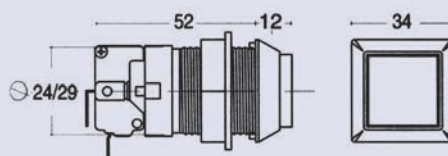
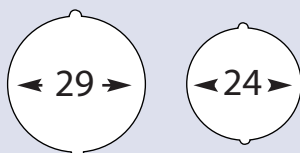

MOD. 05/ TR

- ❑ Pulsante quadrato luminoso in policarbonato trasparente con lampadina incorporata.
- ❑ Contatti: 1 microswitch Honeywell come dotazione standard.
- ❑ Portamico con attacco a baionetta antiganciamento.
- ❑ Lampadina: 6v o 12v - 2w o 1,2w o led 12v.
- ❑ Colore della base: trasparente/ rosso/ giallo/ verde/ blu.
- ❑ Colore dei tasti: rosso/ giallo/ blu/ verde/ bianco.
- ❑ Disponibile stampato.

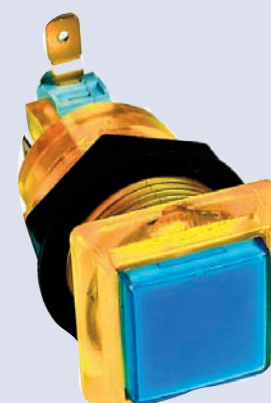

ENGLISH

- Illuminated square pushbutton made of translucent polycarbonate with built-in lamp.
- Contacts: 1 standard Honeywell microswitch.
- Micro-holder with bayonet security connection.
- Lamp: 6v or 12v - 2w or 1,2w or led 12v.
- Base colour: translucent/ red/ yellow/ green/ blue.
- Button colours: red/ blue/ yellow/ green/ white.
- Custom legend lettering available.

FORO DI MONTAGGIO
MOUNTING HOLE

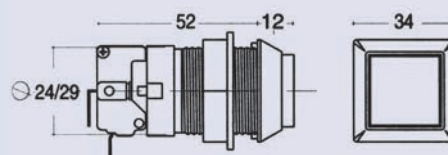
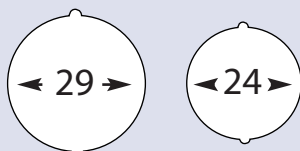

MOD. 08

- ❑ Pulsante rettangolare luminoso in nylon con lampadina incorporata.
- ❑ Contatti: 1 microswitch Honeywell come dotazione standard.
- ❑ Portamico con attacco a baionetta antiganciamento.
- ❑ Lampadina: 6v o 12v - 2w o 1,2w o led 12v.
- ❑ Colore della base: nero.
- ❑ Colore dei tasti: rosso/ giallo/ blu/ verde/ bianco.
- ❑ Disponibile stampato.

ENGLISH

- Illuminated rectangular pushbutton made of nylon with built-in lamp.
- Contacts: 1 Honeywell microswitch fitted as standard.
- Micro-holder with bayonet security connection.
- Lamp: 6v or 12v - 2w or 1,2w or led 12v.
- Base colour: black.
- Button colours: red/ yellow/ blue/ green/ white.
- Custom legend lettering available.

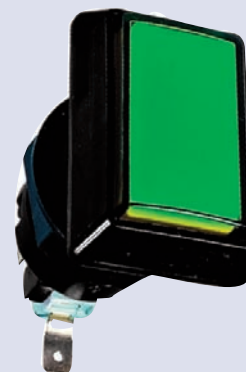

FORO DI MONTAGGIO
MOUNTING HOLE

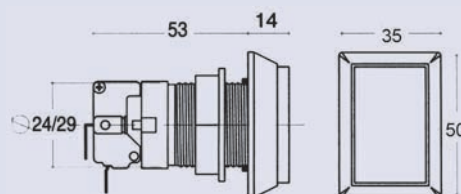
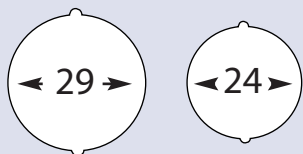

MOD. 08/ TR

- ❑ Pulsante rettangolare luminoso in policarbonato trasparente con lampadina incorporata.
- ❑ Contatti: 1 microswitch Honeywell come dotazione standard.
- ❑ Portamico con attacco a baionetta antiganciamento.
- ❑ Lampadina: 6v o 12v - 2w o 1,2w o led 12v.
- ❑ Colore della base: trasparente/ rosso/ giallo/ verde/ blu.
- ❑ Colore dei tasti: rosso/ giallo/ blu/ verde/ bianco.
- ❑ Disponibile stampato.

ENGLISH

- Illuminated rectangular pushbutton made of translucent polycarbonate built-in lamp.
- Contacts: 1 Honeywell microswitch fitted as standard.
- Micro-holder with bayonet security connection.
- Lamp: 6v or 12v - 2w or 1,2w or led 12v.
- Base colour: translucent/ red/ yellow/ green/ blue.
- Button colours: red/ yellow/ blue/ green/ white.
- Custom legend lettering available.



FORO DI MONTAGGIO
MOUNTING HOLE

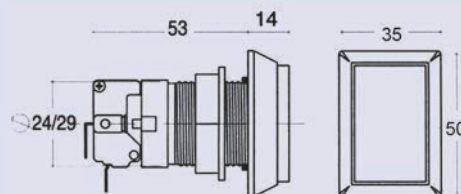
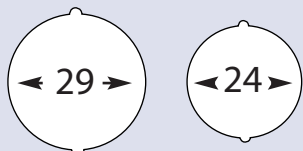

MOD. 09

- ❑ Pulsante quadrato luminoso in nylon con lampadina incorporata.
- ❑ Contatti: 1 microswitch Honeywell come dotazione standard.
- ❑ Portamico con attacco a baionetta antiganciamento.
- ❑ Lampadina: 6v o 12v - 2w o 1,2w o led 12v.
- ❑ Colore della base: nero.
- ❑ Colore dei tasti: rosso/ giallo/ blu/ verde/ bianco.

ENGLISH

- Illuminated square pushbutton made of nylon with built-in lamp.
- Contacts: 1 standard Honeywell microswitch fitted as standard.
- Micro-holder with bayonet security connection.
- Lamp: 6v or 12v - 2w or 1,2w or led 12v.
- Base colour: black.
- Button colours: red/ yellow/ blue/ green/ white.



FORO DI MONTAGGIO
MOUNTING HOLE

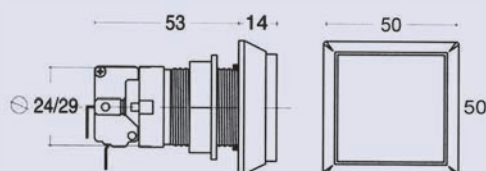
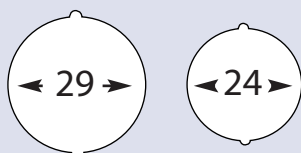

MOD. 09/ TR

- ❑ Pulsante quadrato luminoso in policarbonato trasparente con lampadina incorporata.
- ❑ Contatti: 1 microswitch Honeywell come dotazione standard.
- ❑ Portamico con attacco a baionetta antiganciamento.
- ❑ Lampadina: 6v o 12v - 2w o 1,2w o led 12v.
- ❑ Colore della base: trasparente/ rosso/ giallo/ verde/ blu.
- ❑ Colore dei tasti: rosso/ giallo/ blu/ verde/ bianco.

ENGLISH

- Illuminated square pushbutton made of translucent polycarbonate with built-in lamp.
- Contacts: 1 standard Honeywell microswitch fitted as standard.
- Micro-holder with bayonet security connection.
- Lamp: 6v or 12v - 2w or 1,2w or led 12v.
- Base colour: translucent/ red/ yellow/ green/ blue.
- Button colours: red/ yellow/ blue/ green/ white.



FORO DI MONTAGGIO
MOUNTING HOLE

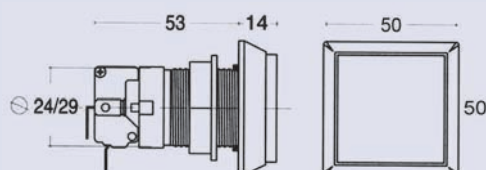
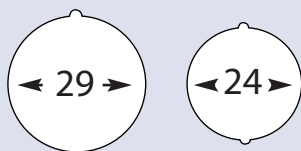

MOD. 015

- Pulsante quadrato luminoso in nylon con lampadina incorporata.
- Contatti: 1 microswitch Honeywell come dotazione standard.
- Portamicro con attacco a baionetta antiganciamento.
- Lampadina: 6v o 12v - 2w o 1,2w o led 12v.
- Colore della base: nero satinato.
- Colore dei tasti: rosso/ giallo/ blu/ verde/ bianco.
- Disponibile stampato.

ENGLISH

- Illuminated square pushbutton made of nylon with built-in lamp.
- Contacts: 1 standard Honeywell microswitch fitted as standard.
- Micro-holder with bayonet security connection.
- Lamp: 6v or 12v - 2w or 1,2w or led 12v.
- Base colour: glazed black.
- Button colours: red/ yellow/ blue/ green/ white.
- Custom legend lettering available.



FORO DI MONTAGGIO
MOUNTING HOLE

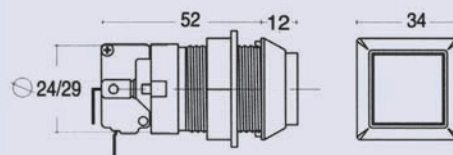
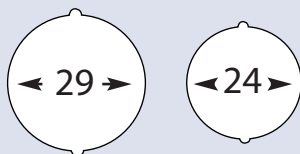

MOD. 018

- Pulsante rettangolare luminoso in nylon con lampadina incorporata.
- Contatti: 1 microswitch Honeywell come dotazione standard.
- Lampadina: 6v o 12v - 2w o 1,2w o led 12v.
- Colore della base: nero satinato.
- Colore dei tasti: rosso/ giallo/ blu/ verde/ bianco.
- Disponibile stampato.

ENGLISH

- Illuminated rectangular pushbutton made of nylon with built-in lamp.
- Contacts: 1 standard Honeywell microswitch.
- Micro-holder with bayonet security connection.
- Lamp: 6v or 12v - 2w or 1,2w or led 12v.
- Base colour: glazed black.
- Button colours: red/ yellow/ blue/ green/ white.
- Custom legend lettering available.



FORO DI MONTAGGIO
MOUNTING HOLE

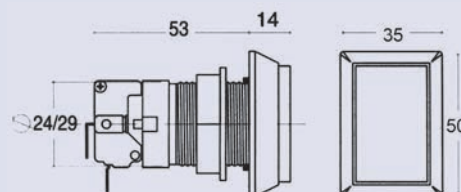
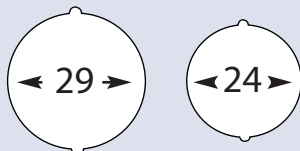

MOD. 024/ TR

- ❑ Pulsante luminoso in policarbonato trasparente con lampadina incorporata.
- ❑ Contatti: 1 microswitch Honeywell come dotazione standard.
- ❑ Portamicro con attacco a baionetta antiganciamento.
- ❑ Lampadina: 6v o 12v - 2w o 1,2w o led 12v.
- ❑ Colore della base: trasparente/ rosso/ giallo/ blu/ verde.
- ❑ Colore dei tasti: rosso/ giallo/ blu/ verde/ bianco.
- ❑ Disponibile stampato.



ENGLISH

- Illuminated square pushbutton made of translucent polycarbonate with built-in lamp.
- Contacts: 1 standard Honeywell microswitch.
- Micro-holder with bayonet security connection.
- Lamp: 6v or 12v - 2w or 1,2w or led 12v.
- Base colour: translucent/ red/ yellow/ blue/ green.
- Button colours: red/ yellow/ blue/ green/ white.
- Custom legend lettering available.

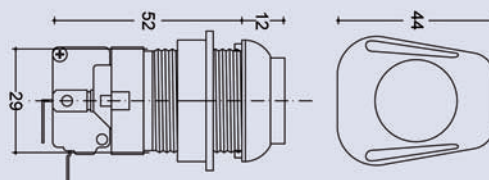

FORO DI MONTAGGIO
MOUNTING HOLE



MOD. 025/ TR

- ❑ Pulsante quadrato luminoso in policarbonato trasparente con lampadina incorporata.
- ❑ Contatti: 1 microswitch Honeywell come dotazione standard.
- ❑ Portamicro con attacco a baionetta antiganciamento.
- ❑ Lampadina: 6v o 12v - 2w o 1,2w o led 12v.
- ❑ Colore della base: trasparente/ rosso/ giallo/ blu/ verde.
- ❑ Colore dei tasti: rosso/ giallo/ blu/ verde/ bianco.
- ❑ Disponibile stampato.



ENGLISH

- Illuminated square pushbutton made of translucent polycarbonate with built-in lamp.
- Contacts: 1 standard Honeywell microswitch.
- Micro-holder with bayonet security connection.
- Lamp: 6v or 12v - 2w or 1,2w or led 12v.
- Base colour: translucent/ red/ yellow/ blue/ green.
- Button colours: red/ yellow/ blue/ green/ white.
- Custom legend lettering available.

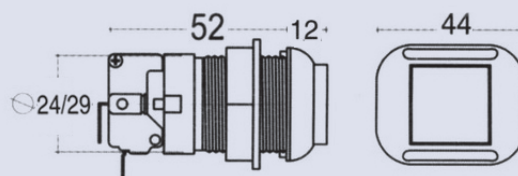

FORO DI MONTAGGIO
MOUNTING HOLE

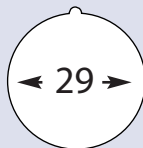

MOD. 045

- ❑ Pulsante rotondo luminoso a basso profilo in nylon con lampadina incorporata.
- ❑ Contatti: 1 microswitch Honeywell come dotazione standard.
- ❑ Portamico con attacco a baionetta antiganciamento.
- ❑ Lampadina: 6v o 12v - 2w o 1,2w o led 12v.
- ❑ Colore della base: nero satinato.
- ❑ Colore dei tasti: rosso/ giallo/ blu/ verde/ bianco.
- ❑ Disponibile stampato.



ENGLISH

- Illuminated square pushbutton made of translucent polycarbonate with built-in lamp.
- Contacts: 1 standard Honeywell microswitch.
- Micro-holder with bayonet security connection.
- Lamp: 6v or 12v - 2w or 1,2w or led 12v.
- Base colour: glazed black.
- Button colours: red/ yellow/ blue/ green/ white.
- Custom legend lettering available.

FORO DI MONTAGGIO
MOUNTING HOLE

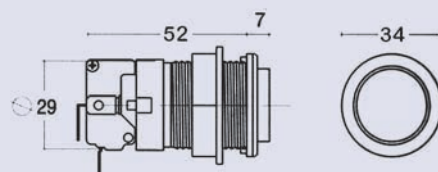
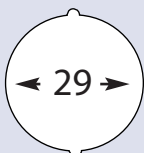

MOD. 050/ SM

- ❑ Pulsante quadrato miniaturizzato in nylon con lampadina incorporata.
- ❑ Contatti: 1 subminiatureswitch come dotazione standard.
- ❑ Portamico con attacco a baionetta antiganciamento.
- ❑ Lampadina: 6v o 12v - 2w o 1,2w o led 12 v.
- ❑ Colore della base: nero satinato.
- ❑ Colore dei tasti: rosso/ giallo/ blu/ verde/ bianco.
- ❑ Disponibile stampato.



ENGLISH

- Illuminated square miniature pushbutton, made of nylon with built-in lamp.
- Contacts: 1 standard Honeywell microswitch fitted as standard.
- Micro-holder with bayonet security connection.
- Lamp: 6v or 12v - 2w or 1,2w or led 12v.
- Base: glazed black.
- Button colours: red/ blue/ yellow/ green/ white.
- Custom legend lettering available.

FORO DI MONTAGGIO
MOUNTING HOLE

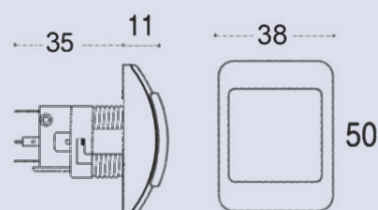
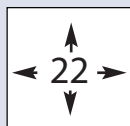

MOD. 050/ SAT

- ❑ Pulsante quadrato luminoso in nylon con lampadina incorporata.
- ❑ Contatti: 1 microswitch Honeywell come dotazione standard.
- ❑ Portamico con attacco a baionetta antiganciamento.
- ❑ Lampadina: 6v o 12v - 2w o 1,2w o led 12v.
- ❑ Colore della base: nero satinato.
- ❑ Colore dei tasti: rosso/ giallo/ blu/ verde/ bianco.
- ❑ Disponibile stampato.



ENGLISH

- Illuminated square pushbutton made of nylon with built-in lamp.
- Contacts: 1 standard Honeywell microswitch.
- Micro-holder with bayonet security connection.
- Lamp: 6v or 12v - 2w or 1,2w or led 12v.
- Base colour: glazed black.
- Button colours: red/ yellow/ blue/ green/ white.
- Custom legend lettering available.

FORO DI MONTAGGIO
MOUNTING HOLE

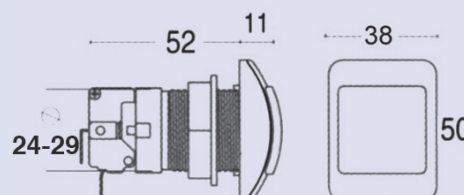
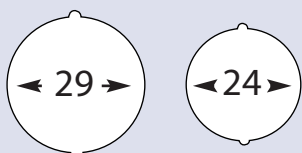

MOD. 050/ TR

- ❑ Pulsante quadrato luminoso in policarbonato trasparente con lampadina incorporata.
- ❑ Contatti: 1 microswitch Honeywell come dotazione standard.
- ❑ Portamico con attacco a baionetta antiganciamento.
- ❑ Lampadina: 6v o 12v - 2w o 1,2w o led 12v.
- ❑ Colore della base: trasparente/ rosso/ giallo/ blu/ verde.
- ❑ Colore dei tasti: rosso/ giallo/ blu/ verde/ bianco.
- ❑ Disponibile stampato.

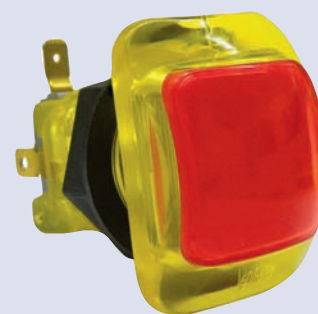

ENGLISH

- Illuminated square pushbutton made of translucent polycarbonate with built-in lamp.
- Contacts: 1 standard Honeywell microswitch.
- Micro-holder with bayonet security connection.
- Lamp: 6v or 12v - 2w or 1,2w or led 12v.
- Base colour: translucent/ red/ yellow/ blue/ green.
- Button colours: red/ yellow/ blue/ green/ white.
- Custom legend lettering available.

FORO DI MONTAGGIO
MOUNTING HOLE

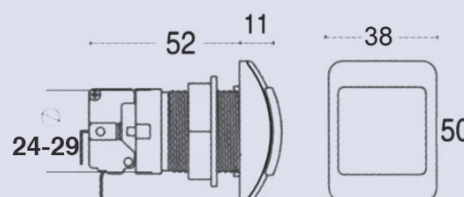
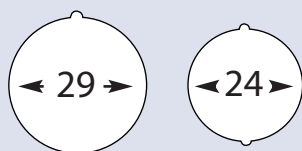

MOD. 055/ C

- ❑ Pulsante quadrato luminoso a basso profilo in policarbonato trasparente con cornice in nylon e lampadina incorporata.
- ❑ Contatti: 1 microswitch Honeywell come dotazione standard.
- ❑ Portamicro con attacco a baionetta antiganciamento.
- ❑ Lampadina: 6v o 12v - 2w o 1,2w o led 12v.
- ❑ Colore della base: trasparente/ rosso/ giallo/ blu/ verde.
- ❑ Colore della cornice: rosso/ giallo/ blu/ verde/ bianco.
- ❑ Colore dei tasti: rosso/ giallo/ blu/ verde/ bianco.
- ❑ Disponibile stampato.



ENGLISH

- Illuminated square pushbutton low profile made of translucent polycarbonate with frame in nylon and built-in lamp.
- Contacts: 1 standard Honeywell microswitch.
- Micro-holder with bayonet security connection.
- Lamp: 6v or 12v - 2w or 1,2w or led 12v.
- Base colour: translucent/ red/ yellow/ blue/ green.
- Frame colour: red/ yellow/ blue/ green/ white.
- Button colours: red/ yellow/ blue/ green/ white.
- Custom legend lettering available.

FORO DI MONTAGGIO
MOUNTING HOLE

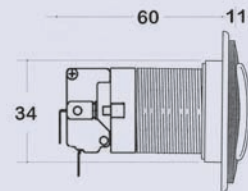
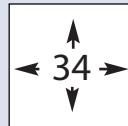

MOD. 055/ SAT

- ❑ Pulsante quadrato luminoso a basso profilo in nylon con lampadina incorporata.
- ❑ Contatti: 1 microswitch Honeywell standard.
- ❑ Portamicro con attacco a baionetta antiganciamento.
- ❑ Lampadina: 6v o 12v - 2w o 1,2w o led 12v.
- ❑ Colore della base: nero satinato.
- ❑ Colore dei tasti: rosso/ giallo/ blu/ verde/ bianco.
- ❑ Disponibile stampato.



ENGLISH

- Illuminated square pushbutton low profile made of nylon with built-in lamp.
- Contacts: 1 standard Honeywell microswitch fitted in standard.
- Micro-holder with bayonet security connection.
- Lamp: 6v or 12v - 2w or 1,2w or led 12v.
- Base colour: glazed black.
- Button colours: red/ yellow/ blue/ green/ white.
- Custom legend lettering available.

FORO DI MONTAGGIO
MOUNTING HOLE

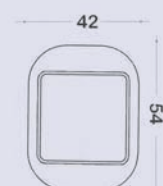
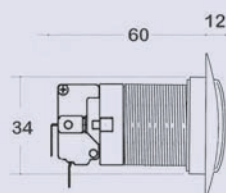
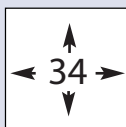

MOD. 055/ SM

- ❑ Pulsante quadrato luminoso a basso profilo miniaturizzato in nylon con lampadina incorporata.
- ❑ Contatti: 1 subminiature switch Honeywell come dotazione standard.
- ❑ Portamico con attacco a baionetta antiganciamento.
- ❑ Lampadina: 6v o 12v - 2w o 1,2w o led 12v.
- ❑ Colore della base: nero satinato.
- ❑ Colore dei tasti: rosso/ giallo/ blu/ verde/ bianco.
- ❑ Disponibile stampato.

ENGLISH

- Illuminated square pushbutton low profile made of nylon with built-in lamp.
- Contacts: 1 standard subminiatureswitch fitted as standard.
- Micro-holder with bayonet security connection.
- Lamp: 6v or 12v - 2w or 1,2w or led 12v.
- Base colour: glazed black.
- Button colours: red/ yellow/ blue/ green/ white.
- Custom legend lettering available.



FORO DI MONTAGGIO
MOUNTING HOLE

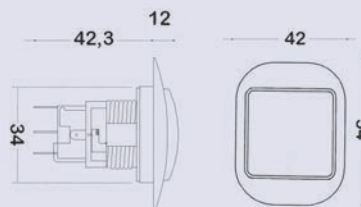
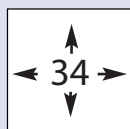

MOD. 055/ TR

- ❑ Pulsante quadrato luminoso a basso profilo in policarbonato trasparente con lampadina incorporata.
- ❑ Contatti: 1 microswitch Honeywell come dotazione standard.
- ❑ Portamico con attacco a baionetta antiganciamento.
- ❑ Lampadina: 6v o 12v - 2w o 1,2w o led 12v.
- ❑ Colore della base: trasparente/ rosso/ giallo/ blu/ verde.
- ❑ Colore dei tasti: rosso/ giallo/ blu/ verde/ bianco.
- ❑ Disponibile stampato.

ENGLISH

- Illuminated square pushbutton low profile made of translucent polycarbonate with built-in lamp.
- Contacts: 1 standard Honeywell microswitch.
- Micro-holder with bayonet security connection.
- Lamp: 6v or 12v - 2w or 1,2w or led 12v.
- Base colour: translucent/ red/ yellow/ blue/ green.
- Button colours: red/ yellow/ blue/ green/ white.
- Custom legend lettering available.



FORO DI MONTAGGIO
MOUNTING HOLE

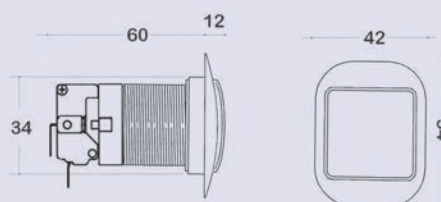
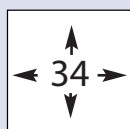

MOD. 060/ SAT

- ❑ Pulsante triangolare luminoso in nylon nero con lampadina incorporata.
- ❑ Contatti: 1 microswitch Honeywell come dotazione standard.
- ❑ Portamico con attacco a baionetta antiganciamento.
- ❑ Lampadina: 6v o 12v - 2w o 1,2wo led 12v.
- ❑ Colore della base: nero satinato.
- ❑ Colore dei tasti: rosso/ giallo/ blu/ verde/ bianco.
- ❑ Disponibile stampato.

ENGLISH

- Illuminated triangular pushbutton made black nylon with built-in lamp.
- Contacts: 1 standard Honeywell microswitch fitted as standard.
- Micro-holder with bayonet security connection.
- Lamp: 6v or 12v - 2w or 1,2w or led 12v.
- Base colour: glazed black.
- Button colours: red/ yellow/ blue/ green/ white.
- Custom legend lettering available.

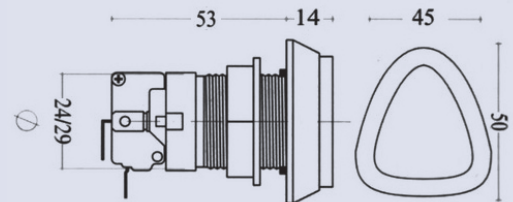

FORO DI MONTAGGIO
MOUNTING HOLE

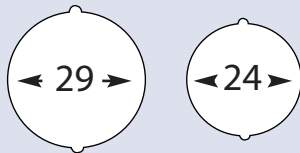

MOD. 060/ TR

- ❑ Pulsante triangolare luminoso in policarbonato trasparente con lampadina incorporata.
- ❑ Contatti: 1 microswitch Honeywell come dotazione standard.
- ❑ Portamico con attacco a baionetta antiganciamento.
- ❑ Lampadina: 6v o 12v - 2w o 1,2wo led 12v.
- ❑ Colore della base: trasparente/ rosso/ giallo/ blu/ verde.
- ❑ Colore dei tasti: rosso/ giallo/ blu/ verde/ bianco.
- ❑ Disponibile stampato.

ENGLISH

- Illuminated triangular pushbutton made of translucent polycarbonate with built-in lamp.
- Contacts: 1 standard Honeywell microswitch.
- Micro-holder with bayonet security connection.
- Lamp: 6v or 12v - 2w or 1,2w or led 12v.
- Base colour: translucent/ red/ yellow/ blue/ green.
- Button colours: red/ yellow/ blue/ green/ white.
- Custom legend lettering available.

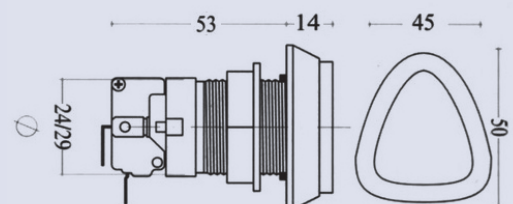

FORO DI MONTAGGIO
MOUNTING HOLE

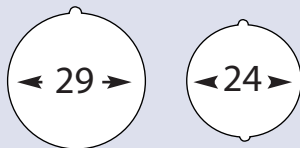

MOD. 080/ SAT

- ❑ Pulsante rettangolare luminoso in nylon nero con lampadina incorporata.
- ❑ Contatti: 1 microswitch Honeywell come dotazione standard.
- ❑ Portamico con attacco a baionetta antiganciamento.
- ❑ Lampadina: 6v o 12v - 2w o 1,2w o led 12v.
- ❑ Colore della base: nero satinato.
- ❑ Colore dei tasti: rosso/ giallo/ blu/ verde/ bianco.
- ❑ Disponibile stampato.



ENGLISH

- Illuminated rectangular pushbutton made of black nylon with built-in lamp.
- Contacts: 1 standard Honeywell microswitch fitted as standard.
- Micro-holder with bayonet security connection.
- Lamp: 6v or 12v - 2w or 1,2w or led 12v.
- Base colour: glazed black.
- Button colours: red/ yellow/ blue/ green/ white.
- Custom legend lettering available.

FORO DI MONTAGGIO
MOUNTING HOLE

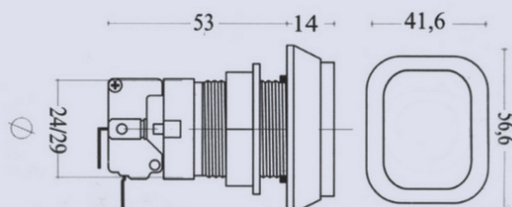
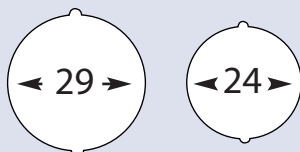

MOD. 080/ TR

- ❑ Pulsante rettangolare luminoso in policarbonato trasparente con lampadina incorporata.
- ❑ Contatti: 1 microswitch Honeywell come dotazione standard.
- ❑ Portamico con attacco a baionetta antiganciamento.
- ❑ Lampadina: 6v o 12v - 2w o 1,2w o led 12v.
- ❑ Colore della base: trasparente/ rosso/ giallo/ blu/ verde.
- ❑ Colore dei tasti: rosso/ giallo/ blu/ verde/ bianco.
- ❑ Disponibile stampato.



ENGLISH

- Illuminated rectangular pushbutton made of translucent polycarbonate with built-in lamp.
- Contacts: 1 standard Honeywell microswitch.
- Micro-holder with bayonet security connection.
- Lamp: 6v or 12v - 2w or 1,2w or led 12v.
- Base colour: translucent/ red/ yellow/ blue/ green.
- Button colours: red/ yellow/ blue/ green/ white.
- Custom legend lettering available.

FORO DI MONTAGGIO
MOUNTING HOLE

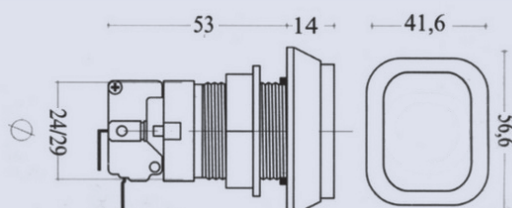
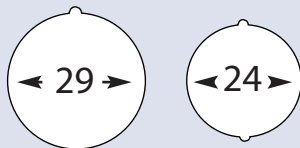

MOD. 085

- ❑ Pulsante rettangolare luminoso a basso profilo in nylon con lampadina incorporata.
- ❑ Contatti: 1 microswitch Honeywell standard.
- ❑ Portamico con attacco a baionetta antiganciamento.
- ❑ Lampadina: 6v o 12v - 2w o 1,2w o led 12v.
- ❑ Colore della base: nero satinato.
- ❑ Colore dei tasti: rosso/ giallo/ blu/ verde/ bianco.
- ❑ Disponibile stampato.



ENGLISH

- Illuminated rectangular pushbutton low profile made of nylon with built-in lamp.
- Contacts: 1 standard Honeywell microswitch fitted in standard.
- Micro-holder with bayonet security connection.
- Lamp: 6v or 12v - 2w or 1,2w or led 12v.
- Base colour: glazed black.
- Button colours: red/ yellow/ blue/ green/ white.
- Custom legend lettering available.

FORO DI MONTAGGIO
MOUNTING HOLE

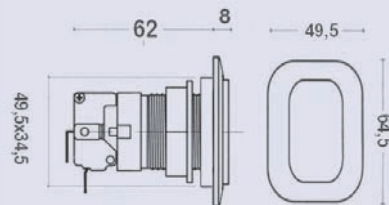
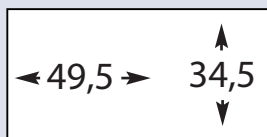

MOD. 090

- ❑ Pulsante quadrato luminoso grande a basso profilo in nylon con lampadina incorporata. Nuovo design.
- ❑ Contatti: 1 microswitch Honeywell come dotazione standard.
- ❑ Portamico con attacco a baionetta antiganciamento.
- ❑ Lampadina: 6v o 12v - 2w o 1,2w o led 12v.
- ❑ Colore della base: nero satinato.
- ❑ Colore dei tasti: rosso/ giallo/ blu/ verde/ bianco.
- ❑ Disponibile stampato.



ENGLISH

- Illuminated square pushbutton large low profile made of nylon with built-in lamp. New design.
- Contacts: 1 standard Honeywell microswitch fitted in standard.
- Micro-holder with bayonet security connection.
- Lamp: 6v or 12v - 2w or 1,2w or led 12v.
- Base colour: glazed black.
- Button colours: red/ yellow/ blue/ green/ white.
- Custom legend lettering available.

FORO DI MONTAGGIO
MOUNTING HOLE

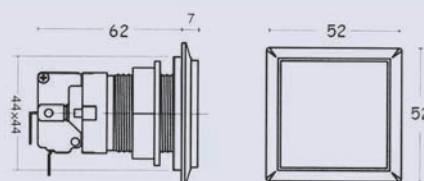
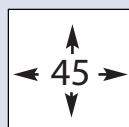

MOD. 095/ SAT

- Pulsante quadrato luminoso a basso profilo in nylon con lampadina incorporata.
- Contatti: 1 subminiatureswitch come dotazione standard.
- Portamico con attacco a baionetta antiganciamento.
- Lampadina: 6v o 12v - 2w o 1,2w o led 12v.
- Colore della base: nero satinato.
- Colore dei tasti: rosso/ giallo/ blu/ verde/ bianco.
- Disponibile stampato.

ENGLISH

- Illuminated square pushbutton low profile made of nylon with built-in lamp.
- Contacts: 1 standard Honeywell microswitch fitted in standard.
- Micro-holder with bayonet security connection.
- Lamp: 6v or 12v - 2w or 1,2w or led 12v.
- Base colour: glazed black.
- Button colours: red/ yellow/ blue/ green/ white.
- Custom legend lettering available.



FORO DI MONTAGGIO
MOUNTING HOLE

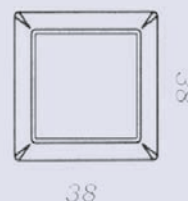
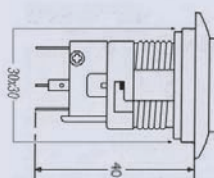
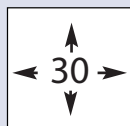

MOD. 105

- Pulsante quadrato luminoso in policarbonato trasparente con cornice in nylon.
- Contatti: 1 microswitch Honeywell come dotazione standard.
- Portamico con attacco a baionetta antiganciamento.
- Illuminazione LED 12V.
- Colore della base: trasparente, rosso, giallo, blu, verde.
- Colore della cornice: rosso, giallo, blu, verde, nero, cromato.
- Colore dei tasti: rosso, giallo, blu, verde, bianco.
- Disponibile stampato.



ENGLISH

- Illuminated square pushbutton made of translucent polycarbonate with frame in nylon and.
- Contacts: 1 standard Honeywell microswitch.
- Micro-holder with bayonet security connection.
- Lighting LED 12V.
- Base colour: translucent, red, yellow, blue, green.
- Frame colour: red, yellow, blue, green, white, black, chrome.
- Button colour: red, yellow, blue, green, white.
- Custom legend lettering available.

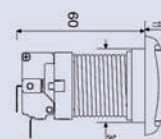
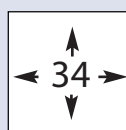

MOD. 108

- Pulsante quadrato, luminoso in policarbonato trasparente o nylon.
- Contatti: 1 microswitch Panasonic come dotazione standard
- Portamico con attacco a baionetta antiganciamento
- Colore della base: nero, trasparente, rosso, giallo, blu, verde, cromo, oro
- Colore dei tasti: bianco, rosso, giallo, blu, verde.
- Illuminazione a LED 12V.
- Disponibile stampato

ENGLISH

- Illuminated square pushbutton made of translucent polycarbonate or nylon.
- Contacts: 1 standard Panasonic microswitch.
- Micro-holder with bayonet security connection.
- Base colour: black, translucent, red, yellow, blue, green, chrome, gold.
- Button colours: white, red, yellow, blue, green.
- Lighting LED 12V.
- Custom legend lettering available.



FORO DI MONTAGGIO
MOUNTING HOLE

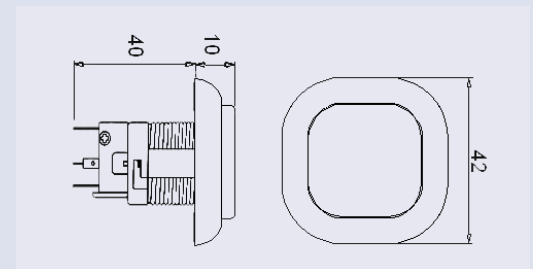
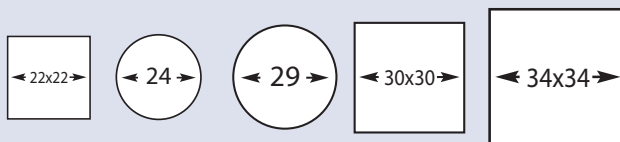

MOD. 108 F

- Caratteristiche come modello 108;
- montaggio facile e rapido a pressione senza ghiera

ENGLISH

- Features such as model 108,
- Quick and easy installation without pressure ring



FORO DI MONTAGGIO
MOUNTING HOLE

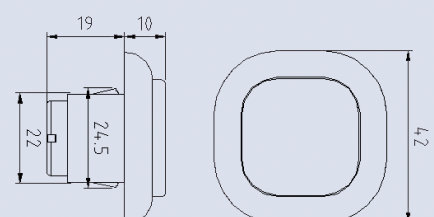

MOD. 109

- Pulsante quadrato, luminoso in policarbonato trasparente o nylon.
- Contatti: 1 microswitch Panasonic come dotazione standard
- Portamico con attacco a baionetta antiganciamento
- Colore della base: nero, trasparente, rosso, giallo, blu, verde, cromo, oro
- Colore dei tasti: bianco, rosso, giallo, blu, verde.
- Illuminazione a LED 12V.
- Disponibile stampato

ENGLISH

- Illuminated square pushbutton made of translucent polycarbonate or nylon.
- Contacts: 1 standard Panasonic microswitch.
- Micro-holder with bayonet security connection.
- Base colour: black, translucent, red, yellow, blue, green, chrome, gold.
- Button colours: white, red, yellow, blue, green.
- Lighting LED 12V.
- Custom legend lettering available.

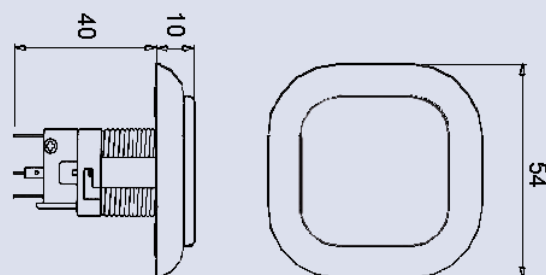

FORO DI MONTAGGIO
MOUNTING HOLE

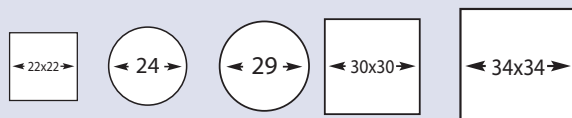

MOD. 109 F

- Caratteristiche come modello 109,
- Con montaggio facile e rapido a pressione senza ghiera

ENGLISH

- Features such as model 109,
- Quick and easy installation without pressure ring

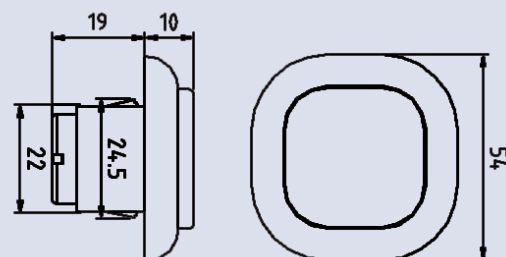

FORO DI MONTAGGIO
MOUNTING HOLE





pulsanti luminosi

Nuova serie "L" - pulsanti a LED

MOD. L100

- ❑ Pulsante a led in policarbonato antiurto, equipaggiato con apposito pcb, sul quale sono assemblati 5 leds ad alta efficienza ed 1 subminiature switch.
- ❑ Montaggio: rapido a pressione.
- ❑ Contatti: connettore maschio 6 poli, passo 2,54 mm.
- ❑ Colore della base: trasparente, rosso, giallo, blu, verde.
- ❑ Colore dei tasti: , rosso, giallo, blu, verde, bianco.
- ❑ Colore della cornice in nylon: rosso, giallo, blu, verde, bianco.

ENGLISH

- Button led shockproof polycarbonate, equipped with a special pcb, which are assembled on the 5 high-efficiency leds, 1 subminiature switch
- Assembly: fast to pressure.
- Contacts: male connector 6-pin 2,54 mm pitch.
- Base colour: translucent, red, yellow, blue, green.
- Button colours: red, yellow, blue, green, white.
- Frame colour of nylon: red, yellow, blue, green, white.
- Custom legend lettering available.



FORO DI MONTAGGIO
MOUNTING HOLE

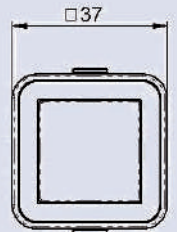
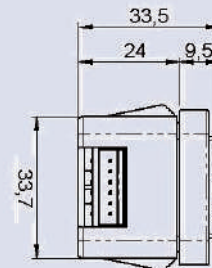
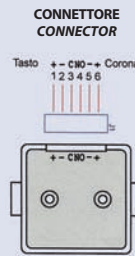

MOD. L200

- ❑ Pulsante a led in policarbonato antiurto, equipaggiato con apposito pcb, sul quale sono assemblati 5 leds ad alta efficienza ed 1 subminiature switch.
- ❑ Montaggio: rapido a pressione
- ❑ Contatti: connettore maschio 6 poli, passo 2,54 mm.
- ❑ Colore della base: trasparente, rosso, giallo, blu, verde.
- ❑ Colore dei tasti: , rosso, giallo, blu, verde, bianco.
- ❑ Colore della cornice in nylon: rosso, giallo, blu, verde, bianco.

ENGLISH

- Button led shockproof polycarbonate, equipped with a special pcb, which are assembled on the 5 high-efficiency leds, 1 subminiature switch
- Assembly: fast to pressure.
- Contacts: male connector 6-pin 2,54 mm pitch.
- Base colour: translucent, red, yellow, blue, green.
- Button colours: red, yellow, blue, green, white.
- Frame colour of nylon: red, yellow, blue, green, white.
- Custom legend lettering available.

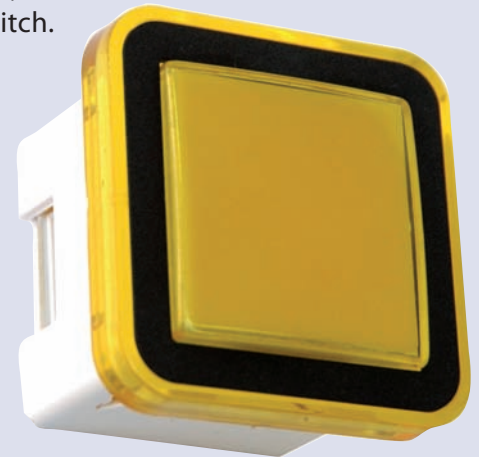

FORO DI MONTAGGIO
MOUNTING HOLE

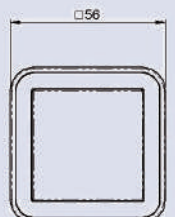
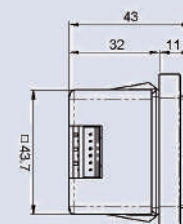
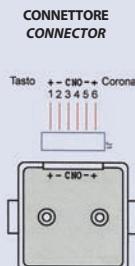
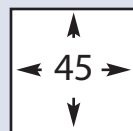

SERIE DELUXE

- I pulsanti serie DELUXE, trattati per ottenere vari effetti, dalla radica al marmo, dal velluto al carbonio, sono stati ideati per offrire la possibilità di personalizzare e dare maggior pregio estetico al videogame. Gli effetti sopra elencati sono stati applicati al modello 025 ma **tutti i pulsanti Edierre possono essere trattati con questo tipo di finiture.**

ILLUMINATED PUSHBUTTONS DELUXE SERIES

The deluxe series pushbuttons are treated in order to have a final result of various effects, from radica to marble, from velvet to carbonium, and have been thought to make videogames more precious.

The finishes here shown are on the 025 model, but all EDIERRE pushbuttons can be treated the same way.



blu venato



legno verde



fantasia fiorato

SERIE ORO

- Ecco alcuni esempi di pulsanti trattati con la finitura ORO, che è disponibile per tutti i pulsanti luminosi EDIERRE.

ILLUMINATED PUSHBUTTONS GOLD SERIES

- Here are some pushbuttons treated with the Deluxe GOLD finishes. Of course, all EDIERRE illuminated pushbutton can be treated the same way.



SERIE CROMO

- Ecco alcuni esempi di pulsanti trattati con la finitura CROMO, che è disponibile per tutti i pulsanti luminosi EDIERRE nelle versioni lucido e satinato.

ILLUMINATED PUSHBUTTONS CHROME SERIES

- Here are some pushbuttons treated with the Deluxe CHROME finishes. Of course, all EDIERRE illuminated pushbutton can be treated the same way.



cromo lucido



cromo satinato

MOD. 040

- ❑ Mini pulsante a tasto quadrato luminoso. Disponibile anche in policarbonato trasparente (Mod. 040/ TR) o con trattamento deluxe.
- ❑ Contatti: 1 subminiatureswitch come dotazione standard.
- ❑ Portamico con attacco a baionetta antiganciamento.
- ❑ Lampadina incorporata.
- ❑ Colore di base: nero/ trasparente/ rosso/ giallo/ blu/ verde.
- ❑ Colore dei tasti: rosso/ giallo/ blu/ verde/ bianco.
- ❑ Foro di montaggio quadrato: 22 mm
- ❑ Foro di montaggio tondo: 24 mm.



ENGLISH

- Illuminated square pushbutton. Also available made of translucent polycarbonate (Mod. 040/ TR) and deluxe.
- Contacts: 1 standard siminiature switch.
- Micro-holder with bayonet security connection.
- Lamp included.
- Base colour: black/ translucent/ red/ yellow/ blue/ green.
- Button colours: red/ yellow/ blue/ green/ white.
- Square mounting hole: 22 mm.
- Round mounting hole: 24 mm.

FORO DI MONTAGGIO
MOUNTING HOLE

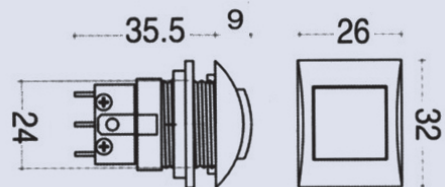
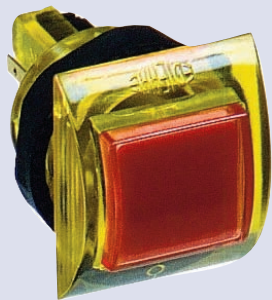
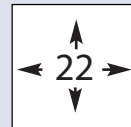

MOD. 040/ TR

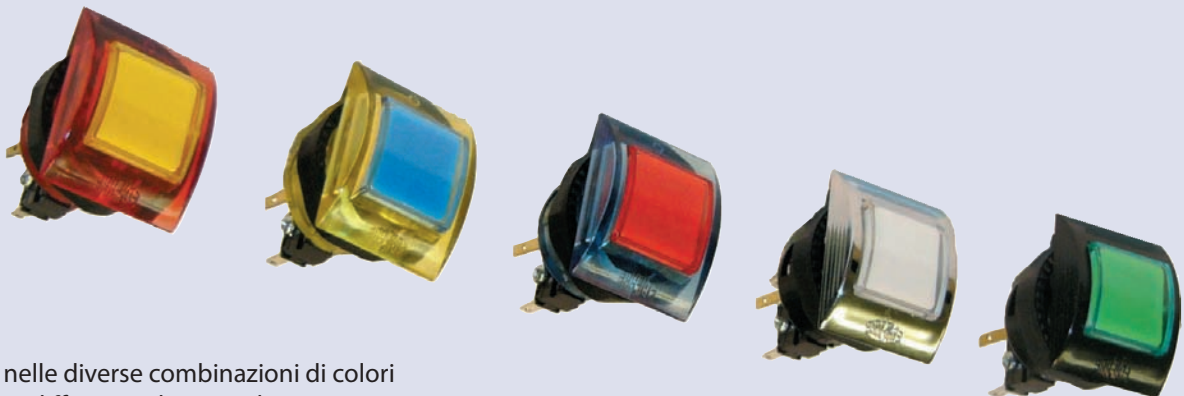

Mod 040 nelle diverse combinazioni di colori
Mod 040 in different colour combinations.

MOD. AX01

- ❑ Pulsante antivandalo indistruttibile, ad alta affidabilità, resistente al fuoco, realizzato completamente in acciaio inox 303.
- ❑ Ingombro massimo sulla plancia è di 24 millimetri di diametro.
- ❑ Il foro di montaggio è circolare da 19 millimetri.
- ❑ Il pulsante è fissato attraverso la classica ghiera ed è fornito di un microswitch miniaturizzato con sistema di serraggio di sicurezza Edierre.



ENGLISH

- Button vandal indestructible, high reliability, fire-resistant, made of stainless steel 303.
- Overall dimensions on the bridge is 24 millimeters in diameter.
- The mounting hole is circular 19 mm.
- The button is fixed through the classical ring and is provided with a miniature microswitch with clamping system security Edierre



FORO DI MONTAGGIO
MOUNTING HOLE

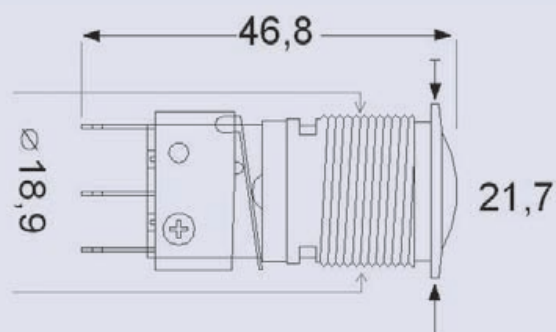
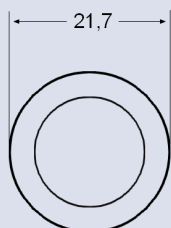
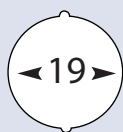

MOD. 07

- ❑ Pulsante rotondo in nylon.
- ❑ Contatti: 1 microswitch Honeywell come dotazione standard.
- ❑ Portamicro con attacco a baionetta antiganciamento.
- ❑ Colore della base: nero.
- ❑ Colore dei tasti: rosso/ giallo/ bianco/ blu/ verde.
- ❑ Disponibile stampato.



FORO DI MONTAGGIO
MOUNTING HOLE

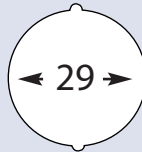

ENGLISH

- Round pushbutton made of nylon.
- Contacts: 1 Honeywell microswitch fitted as standard.
- Micro-holder with bayonet security connection.
- Base colour: black.
- Button colours: red/ yellow/ white/ blue/ green.
- Custom legend lettering available.

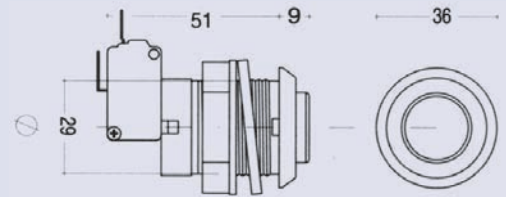

MOD. 07/ Colour

- ❑ Pulsante rotondo in nylon.
- ❑ Contatti: 1 microswitch Honeywell come dotazione standard.
- ❑ Portamicro con attacco a baionetta antiganciamento.
- ❑ Colori base e tasto identici: rosso/ giallo/ bianco/ blu/ verde.
- ❑ Disponibile stampato.



FORO DI MONTAGGIO
MOUNTING HOLE

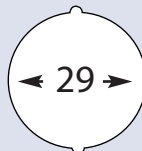

ENGLISH

- Round pushbutton made of nylon.
- Contacts: 1 Honeywell microswitch fitted as standard.
- Micro-holder with bayonet security connection.
- Base button colours: red/ yellow/ white/ blue/ green.
- Custom legend lettering available.

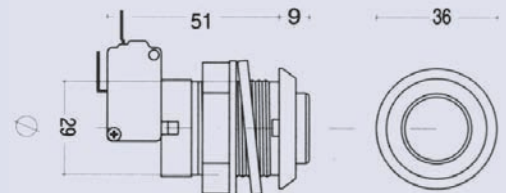

MOD. 07/ TR

- ❑ Pulsante rotondo in policarbonato trasparente. Illuminabile con lampada esterna.
- ❑ Contatti: 1 microswitch Honeywell come dotazione standard.
- ❑ Colori base e tasto identici: rosso/ giallo/ blu/ verde/ trasparente.
- ❑ Disponibile stampato.



FORO DI MONTAGGIO
MOUNTING HOLE

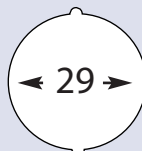

ENGLISH

- Round pushbutton made of translucent polycarbonate. It can be illuminated by external lamp.
- Contacts: 1 Honeywell microswitch fitted as standard.
- Base button colours: red/ yellow/ blue/ green/ translucent.
- Custom legend lettering available.

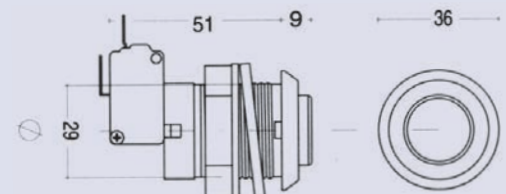

MOD. 06/ T

- ❑ Pulsante triplo in nylon su unica base circolare.
- ❑ Contatti: 3 microswitches Honeywell come dotazione standard.
- ❑ Portamico con attacco a baionetta antiganciamento.
- ❑ Colore della base: nero.
- ❑ Colore dei tasti: rosso/ giallo/ blu/ verde/ bianco.



FORO DI MONTAGGIO
MOUNTING HOLE

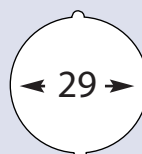

ENGLISH

- Triple pushbutton on a single round base, made of nylon.
- Contacts: 3 Honeywell microswitch fitted as standard.
- Micro-holder with bayonet security connection.
- Base colour: black.
- Button colours: red/ yellow/ blue/ green/ white.

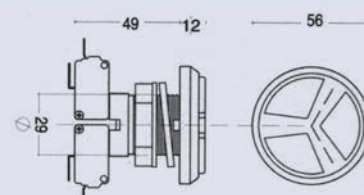

MOD. 06/ D Tondo

- ❑ Pulsante doppio in nylon su unica base circolare.
- ❑ Contatti: 2 microswitches Honeywell come dotazione standard.
- ❑ Portamico con attacco a baionetta antiganciamento:
- ❑ Colore della base: nero.
- ❑ Colore dei tasti: rosso/ giallo/ blu/ verde/ bianco.



FORO DI MONTAGGIO
MOUNTING HOLE

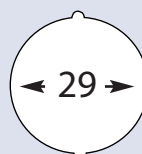

ENGLISH

- Dual pushbutton on a single square base, made of nylon.
- Contacts: 2 Honeywell microswitch fitted as standard.
- Micro-holder with bayonet security connection.
- Base colour: black.
- Button colours: red/ yellow/ blue/ green/ white.

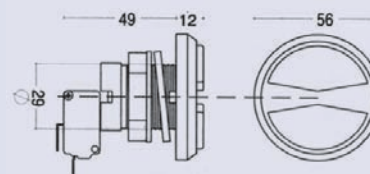

MOD. 06/ D Quadrato

- ❑ Pulsante doppio in nylon su unica base quadrata.
- ❑ Contatti: 2 microswitches Honeywell come dotazione standard.
- ❑ Portamico con attacco a baionetta antiganciamento:
- ❑ Colore della base: nero.
- ❑ Colore dei tasti: rosso/ giallo/ blu/ verde/ bianco.



FORO DI MONTAGGIO
MOUNTING HOLE

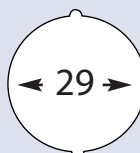

ENGLISH

- Dual pushbutton on a single round base, made of nylon.
- Contacts: 2 Honeywell microswitch fitted as standard.
- Micro-holder with bayonet security connection.
- Base colour: black.
- Button colours: red/ yellow/ blue/ green/ white.

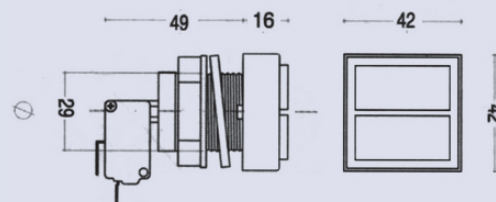

1 DM

- Microswitch porta ad 1 via.
- Door switch single pole.



2 DM

- Microswitch porta ad 2 vie.
- Door switch double pole.



HP

- Microswitch Honeywell per pulsanti.
- Microswitch for pushbutton

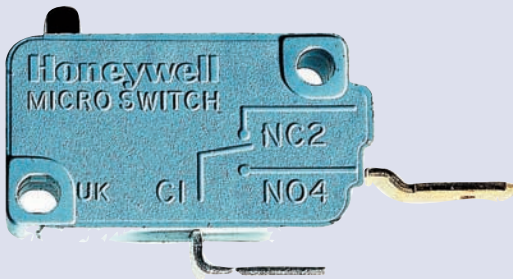

HL

- Microswitch per joystick.
- Microswitch for joystick.

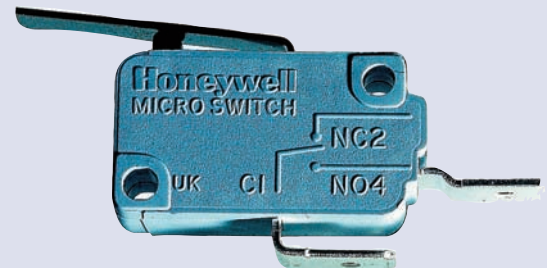

MP

- Sub-miniature switch per minipulsanti.
- Sub-miniature switch for pushbutton.



ML

- Sub-miniature switch for joystick.
- Sub-miniature switch for joystick.

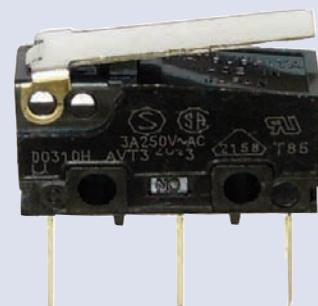

LAMPADINE / LAMPS

- 6v o 12v, 2w o 1,2w.
- 6v o 12v, 2w or 1,2w.

LM 5



LM 10



LED

- 12v.

LD 5



LD 10



**ACCESSORI
BREVETTATI
PER VIDEOGAMES**



**VIDEOGAMES
PATENTED
ACCESSORIES**

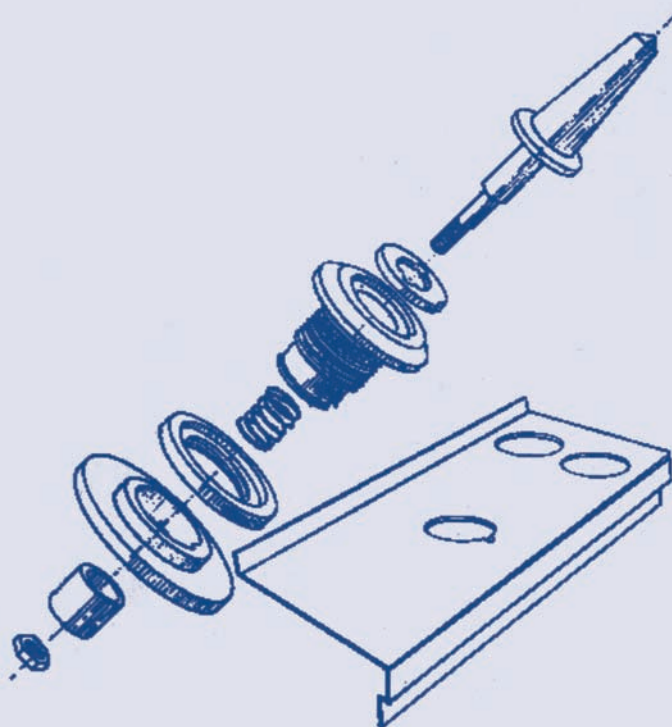

EDIERRE II S.r.l.

Il marchio è di proprietà esclusiva della EDIERRE II s.r.l., unica ideatrice, produttrice e distributrice, anche a livello internazionale, di tutti i prodotti contenuti nel presente catalogo.

I modelli dei prodotti EDIERRE sono depositati.

Tutti i diritti riservati.

Nessuna parte del documento può essere fotocopiata, riprodotta o tradotta in un'altra lingua, senza previo consenso scritto della EDIERRE II s.r.l.

The EDIERRE logo is exclusive property of EDIERRE II s.r.l., the only producer and distributor, at national and international level, of all products shown in this catalogue.

All rights reserved.

It is forbidden to photocopy, reproduce or translate this document or parts of it in any language without prior consent of EDIERRE II s.r.l.



www.edierre.it



EDIERRE II s.r.l.

Sede Commerciale:

Recapito Corrispondenza

00165 Roma

Via Madonna del Riposo, 90

tel. 06 66 29 730 - 66 30 802

fax. 06 66 29 730

e-mail: info@edierre.it

www.edierre.it

Sede Legale:

00175 Roma

Via dell'Aeroporto, 155

